



VIDEOS &
FURTHER
INFORMATION



www.sigmasport.com

INSTALLATION

CONTENTS

BC 5.0 wired
1 + 2 + 3

BC 5.0

1 Cable mount
Item no. 00530

2 Magnet
Item no. 00537

3 Cable ties



BC 5.0 wireless
3 + 4 + 5 + 6

BC 5.0 WL

4 Speed transmitter
Item no. 00540

5 Mount
Item no. 00534

6 Power Magnet
Item no. 00538

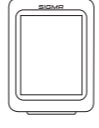

FIRST START

Press 5 sec.

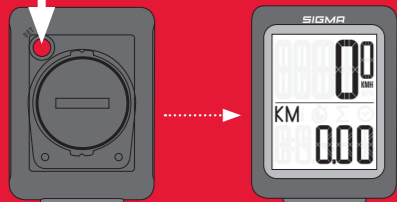

Battery already installed / Már behelyezett elemmel /
Pil zaten takli / Bateria deja instalată /
Батерията вече е поставена / Bateria je nainštalovaná /
Baterija je že nameščena / Bateria je već instalirana /
Акумулятор установлено

INSTALLATION MOUNT

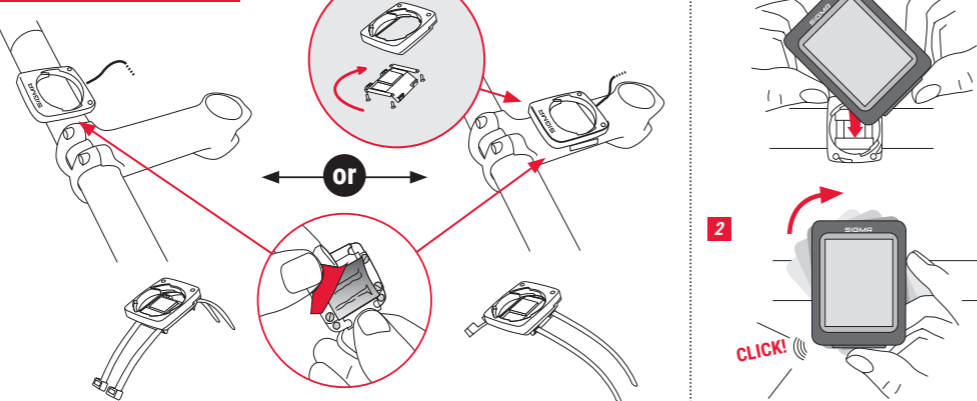

INSTALLATION WIRED SPEED SENSOR

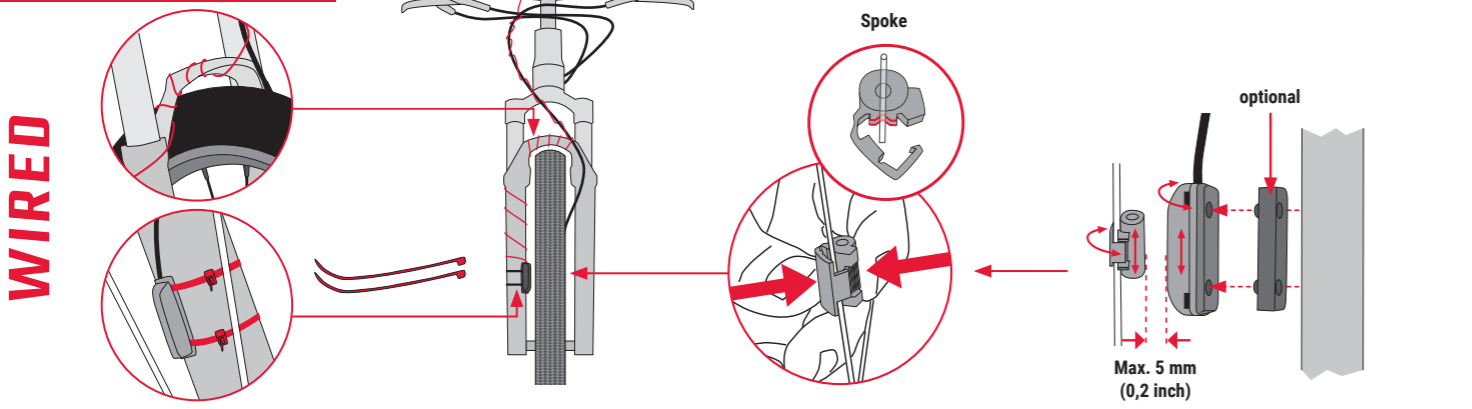

INSTALLATION WIRELESS SPEED TRANSMITTER

Emission frequency: 112 kHz, Max power < 11.37 dBm

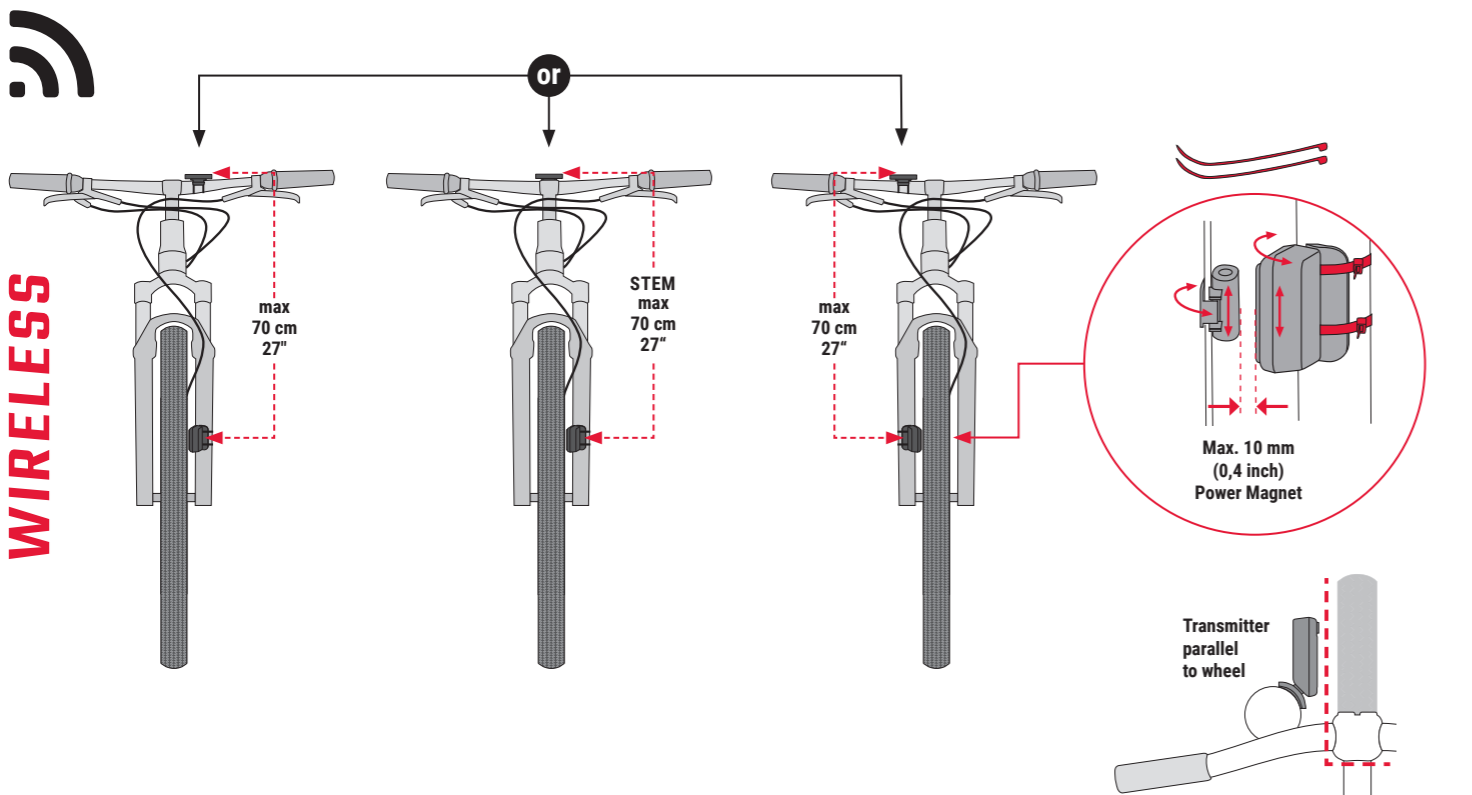

TECHNICAL DATA

<p>EN Computer WIRED:</p> <ul style="list-style-type: none"> Battery type: CR 2032, 3V Battery life: 3 years (When used for 1 hour per day) 	<p>Computer WIRELESS:</p> <ul style="list-style-type: none"> Battery type: CR 2032, 3V Battery life: 2 years (When used for 1 hour per day) <p>Transmitter:</p> <ul style="list-style-type: none"> Battery type: CR 2032, 3V Battery life: 1.5 years (When used for 1 hour per day)
<p>HU VEZETÉKES számítógép:</p> <ul style="list-style-type: none"> Elem típusa: CR 2032, 3V Elem élettartama: 3 év (Napi 1 órá használata esetén) 	<p>VEZETÉK NÉLKÜLI számítógép:</p> <ul style="list-style-type: none"> Elem típusa: CR 2032, 3V Elem élettartama: 2 év (Napi 1 órá használata esetén) <p>Jeladó:</p> <ul style="list-style-type: none"> Elem típusa: CR 2032, 3V Elem élettartama: 1,5 év (Napi 1 órá használata esetén)
<p>FR Kilometre Saati KABLOLU:</p> <ul style="list-style-type: none"> Pil türü: CR 2032, 3V Pil ömrü: 3 yıl (Günde 1 saat kullanıldığında) 	<p>Kilometre Saati KABLLOSUZ:</p> <ul style="list-style-type: none"> Pil türü: CR 2032, 3V Pil ömrü: 2 yıl (Günde 1 saat kullanıldığında) <p>Verici:</p> <ul style="list-style-type: none"> Pil türü: CR 2032, 3V Pil ömrü: 1,5 yıl (Günde 1 saat kullanıldığında)
<p>RO Calculator CABLAT:</p> <ul style="list-style-type: none"> Tipul de baterie: CR 2032, 3V Durata de viață a bateriei: 3 ani (în cazul utilizării timp de 1 oră pe zi) 	<p>Calculator WIRELESS:</p> <ul style="list-style-type: none"> Tipul de baterie: CR 2032, 3V Durata de viață a bateriei: 2 ani (în cazul utilizării timp de 1 oră pe zi) <p>Transmițător:</p> <ul style="list-style-type: none"> Tipul de baterie: CR 2032, 3V Durata de viață a bateriei: 1,5 ani (în cazul utilizării timp de 1 oră pe zi)
<p>BG Компютър с КАБЕЛНА връзка:</p> <ul style="list-style-type: none"> Тип батерия: CR 2032, 3 V Живот на батерията: 3 години (Ако се използва по един час на ден) 	<p>Компютър с БЕЗЖИЧНА връзка:</p> <ul style="list-style-type: none"> Тип батерия: CR 2032, 3 V Живот на батерията: 2 години (Ако се използва по един час на ден) <p>Предавател:</p> <ul style="list-style-type: none"> Тип батерия: CR 2032, 3 V Живот на батерията: 1,5 години (Ако се използва по един час на ден)
<p>SK Počítač je KÁBLOVÝ:</p> <ul style="list-style-type: none"> Typ batérie: CR 2032, 3 V Životnosť batérie: 3 roky (ak sa používa 1 hodinu denne) 	<p>Počítač NIE JE KÁBLOVÝ:</p> <ul style="list-style-type: none"> Typ batérie: CR 2032, 3 V Životnosť batérie: 2 roky (ak sa používa 1 hodinu denne) <p>Vysielač:</p> <ul style="list-style-type: none"> Typ batérie: CR 2032, 3 V Životnosť batérie: 1,5 roka (ak sa používa 1 hodinu denne)
<p>SL Računalnik je POVEZAN:</p> <ul style="list-style-type: none"> tip baterije: CR 2032, 3 V živiljenjska doba baterije: 3 leta (če jo uporabljate eno uro na dan) 	<p>Računalnik ni POVEZAN:</p> <ul style="list-style-type: none"> tip baterije: CR 2032, 3 V živiljenjska doba baterije: 2 leti (če jo uporabljate eno uro na dan) <p>Oddajnik</p> <ul style="list-style-type: none"> tip baterije: CR 2032, 3 V živiljenjska doba baterije: 1,5 leta (če jo uporabljate eno uro na dan)
<p>HR Računalo ŽIČANO:</p> <ul style="list-style-type: none"> Vrsta baterije: CR 2032, 3 V Vijek trajanja baterije: 3 godine (kada se upotrebljava 1 sat dnevno) 	<p>Računalo BEŽIČNO:</p> <ul style="list-style-type: none"> Vrsta baterije: CR 2032, 3 V Vijek trajanja baterije: 2 godine (kada se upotrebljava 1 sat dnevno) <p>Odašiljač:</p> <ul style="list-style-type: none"> Vrsta baterije: CR 2032, 3 V Vijek trajanja baterije: 1,5 godinu (kada se upotrebljava 1 sat dnevno)
<p>UA Комп'ютер ІЗ ПРОВОДОВИМ ПІД'ЄДНАННЯМ:</p> <ul style="list-style-type: none"> тип акумулятора: CR 2032, 3 В; термін служби акумулятора: 3 роки (за умови використання протягом 1 години на день). 	<p>Комп'ютер ІЗ БЕЗПРОВОДОВИМ ПІД'ЄДНАННЯМ:</p> <ul style="list-style-type: none"> тип акумулятора: CR 2032, 3 В; термін служби акумулятора: 2 роки (за умови використання протягом 1 години на день). <p>Передавач:</p> <ul style="list-style-type: none"> тип акумулятора: CR 2032, 3 В; термін служби акумулятора: 1,5 роки (за умови використання протягом 1 години на день).

EU-DECLARATION OF CONFORMITY

We, SIGMA-ELEKTRO GmbH, Dr.-Julius-Leber-Str. 15, D-67433 Neustadt/Weinstraße declare under our responsibility that the product BC 5.0 WR are compliant with the essential requirements of the EMC Directive 2014/30/EU and the RoHS Directive 2011/65/EU. The declaration of conformity can be found at: ce.sigmasport.com/bc50wr

We, SIGMA-ELEKTRO GmbH, Dr.-Julius-Leber-Str. 15, D-67433 Neustadt/Weinstraße declare under our responsibility that the product BC 5.0 WL and the transmitter ATS2021 are compliant with the essential requirements and other relevant requirements of the RED Directive 2014/53/EU and the RoHS Directive 2011/65/EU. The declaration of conformity can be found at: ce.sigmasport.com/bc50wl

EU-KONFORMITÄTSEKLRÄRUNG

Wir, SIGMA-ELEKTRO GmbH, Dr.-Julius-Leber-Str. 15, D-67433 Neustadt/Weinstraße, erklären, dass der Fahrradcomputer BC 5.0 WR bei bestimmungsgemäßer Verwendung den grundlegenden Anforderungen gemäß der EMC Directive 2014/30/EU und der RoHS Directive 2011/65/EU entspricht. Sie finden die Konformitäts-Erklärung unter folgendem Link: ce.sigmasport.com/bc50wr

Wir, SIGMA-ELEKTRO GmbH, Dr. Julius Leber Str. 15, D-67433 Neustadt/Weinstraße erklären, dass der Fahrradcomputer mit Funkübertragung BC 5.0 WL und der Sender ATS2021 bei bestimmungsgemäßer Verwendung den grundlegenden Anforderungen gemäß RED Directive 2014/53/EU und der RoHS Directive 2011/65/EU entsprechen. Sie finden die Konformitäts-Erklärung unter folgendem Link: ce.sigmasport.com/bc50wl

LEGAL STATEMENTS

FEDERAL COMMUNICATION COMMISSION INTERFERENCE STATEMENT

Caution: If any changes or modifications not expressly approved by the party responsible for compliance could void the user's authority to operate the equipment.

This device complies with Part 15 of the FCC Rules. Operation is subject to the following two conditions:
(1) This device may not cause harmful interference, and
(2) This device must accept any interference received, including interference that may cause undesired operation.

The grantee is not responsible for any changes or modifications not expressly approved by the party responsible for compliance. Such modifications could void the user's authority to operate the equipment.
The RF Exposure Compliance distance is 5 millimeters.

NOTE: This equipment has been tested and found to comply with the limits for a Class B digital device, pursuant to part 15 of the FCC Rules. These limits are designed to provide reasonable protection against harmful interference in a residential installation. This equipment generates, uses and can radiate radio frequency energy and, if not installed and used in accordance with the instructions, may cause harmful interference to radio communications. However, there is no guarantee that interference will not occur in a particular installation. If this equipment does cause harmful interference to radio or television reception, which can be determined by turning the equipment off and on, the user is encouraged to try to correct the interference by one or more of the following measures:

- Reorient or relocate the receiving antenna.
- Increase the separation between the equipment and receiver.
- Connect the equipment into an outlet on a circuit different from that to which the receiver is connected.
- Consult the dealer or an experienced radio/TV technician for help.

FCC ID ATS2021: M5LATS2021

INDUSTRY CANADA STATEMENT

This device complies with Innovation, Science and Economic Development Canada licence-exempt RSS standard(s).

Operation is subject to the following two conditions:
(1) this device may not cause interference, and
(2) this device must accept any interference, including interference that may cause undesired operation of the device.

CAN ICES-3(B)/NMB-3(B)

Le présent appareil est conforme aux CNR Innovation, Sciences et Développement économique Canada applicables aux appareils radio exempts de licence. L'exploitation est autorisée aux deux conditions suivantes:

- (1) il ne doit pas produire de brouillage et
- (2) l'utilisateur du dispositif doit être prêt à accepter tout brouillage radioélectrique reçu, même si ce brouillage est susceptible de compromettre le fonctionnement du dispositif.

CAN ICES-3(B)/NMB-3(B)

The device meets the exemption from the routine evaluation limits in section 2.5 of RSS 102 and compliance with RSS-102 RF exposure, users can obtain Canadian information on RF exposure and compliance.

Le dispositif rencontre l'exemption des limites courantes d'évaluation dans la section 2.5 de RSS 102 et la conformité à l'exposition de RSS-102 rf, utilisateurs peut obtenir l'information canadienne sur l'exposition et la conformité de rf.

This transmitter must not be co-located or operating in conjunction with any other antenna or transmitter. This equipment should be installed and operated with a minimum distance of 5 millimeters between the radiator and your body.

Cet émetteur ne doit pas être Co-placé ou ne fonctionnant en même temps qu'aucune autre antenne ou émetteur. Cet équipement devrait être installé et actionné avec une distance minimum de 5 millimètres entre le radiateur et votre corps.

UKCA STATEMENT

Wireless Model

We, SIGMA-ELEKTRO GmbH, declare that the equipment above has been tested in our facility and found compliance with the requirement limits of applicable standards, in accordance with the Radio Equipment Regulations 2017 and the Restriction of the Use of Certain Hazardous Substances in Electrical and Electronic Equipment Regulations 2012. The test record, data evaluation and Equipment Under Test (EUT) configurations represented herein are true and accurate under the standards herein specified.

Wired Model

We, SIGMA-ELEKTRO GmbH, declare that the equipment above has been tested in our facility and found compliance with the requirement limits of applicable standards, in accordance with the Electromagnetic Compatibility Regulations 2016 and the Restriction of the Use of Certain Hazardous Substances in Electrical and Electronic Equipment Regulations 2012. The test record, data evaluation and Equipment Under Test (EUT) configurations represented herein are true and accurate under the standards herein specified.

CE INFORMATION

EN You can find the CE declaration at: ce.sigmasport.com/bc50wr

HU A CE-nyilatkozatot itt találja: ce.sigmasport.com/bc50wr

FR CE beyanını şurada bulabilirsiniz: ce.sigmasport.com/bc50wr

RO Declarația CE o găsiți la: ce.sigmasport.com/bc50wr

BG Можете да откриете Декларацията за съответствие на: ce.sigmasport.com/bc50wr

SK Vyhlásenie CE nájdete na: ce.sigmasport.com/bc50wr

SL Izjavo CE najdete na: ce.sigmasport.com/bc50wr

HR Oznaku CE možete pronaći na: ce.sigmasport.com/bc50wr

UA Ознайомитися з Декларацією ЄС можна за посиланням: ce.sigmasport.com/bc50wr

PL Deklarację CE można znaleźć na: ce.sigmasport.com/bc50wr

FUNCTIONS / SETTINGS

BUTTON OVERVIEW

EN

SET Button: **S**

- Long press >3 sec. = Open/Close Settings
- Short press = SET/OK

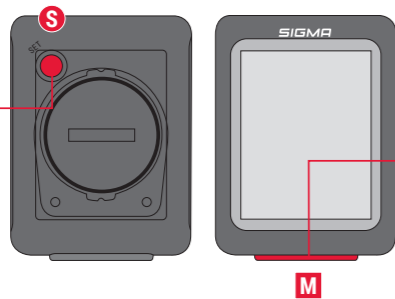

MENU Button: **M**

- Short press = Toggle/Increase value
- Long press >3 sec. = Reset tour data

MENU BASIC BIKE FUNCTIONS

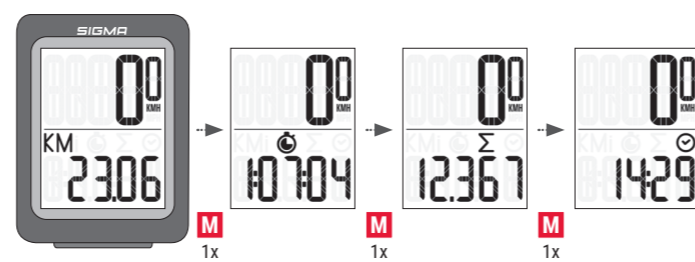

ICON OVERVIEW

- EN KM : trip distance
 ⌚ : trip time
 ∑ : total distance
 ⌚ : clock

- HU KM : út távolsága
 ⌚ : út időtartama
 ∑ : teljes távolság
 ⌚ : óra

- TR KM : tur mesafesi
 ⌚ : tur süresi
 ∑ : toplam mesafe
 ⌚ : saat

- RO KM : distanța călătoriei
 ⌚ : timpul călătoriei
 ∑ : distanța totală
 ⌚ : ceasul

- BG KM : разстояние на обиколката
 ⌚ : време на обиколката
 ∑ : общо разстояние
 ⌚ : часовник

- SK KM : vzdialenosť jazdy
 ⌚ : čas jazdy
 ∑ : celková vzdialenosť
 ⌚ : hodiny

- SL KM : prevožena razdalja
 ⌚ : trajanje vožnje
 ∑ : celotna razdalja
 ⌚ : ura

- HR KM : udaljenost vožnje
 ⌚ : vrijeme vožnje
 ∑ : ukupna udaljenost
 ⌚ : sat

- UA KM : відстань подорожі
 ⌚ : тривалість подорожі
 ∑ : загальна відстань
 ⌚ : годинник

HU

- S: SET (Beállítás) gomb:**
- Hosszan lenyomva tartva = Beállítások megnyitása/bezárása
 - Rövid megnyomás = Beállítás/Jóváhagyás
- M: MENÜ gomb:**
- Rövid megnyomás = Váltás / Érték növelése
 - Hosszan nyomva tartva = Túraadatok visszaállítása

TR

- S: SET (Ayar) Düğmesi:**
- Uzun basın = Ayarları Açar/Kapatır
 - Kısa basın = SET (Ayar)/OK (Tamam)
- M: MENU (Menü) Düğmesi:**
- Kısa basın = Değeri değiştirir/Değeri artırır
 - Uzun basın = Tur verilerini sıfırlar

RO

- S: Butonul SETARE:**
- Apăsare lungă = deschidere/inchidere setării
 - Apăsare scurtă = SETARE/OK
- M: Butonul MENU:**
- Apăsare scurtă = comutare/creșterea valorii
 - Apăsare lungă = resetarea datelor turului

BG

- S: БУТОН SET (НАСТРОЙКА):**
- Дълго натискане = Отваряне/затваряне на настройките
 - Кратко натискане = Настройване/OK
- M: БУТОН MENU (МЕНЮ):**
- Кратко натискане = Превключване/увеличаване на стойност
 - Дълго натискане = Нулиране на данните за обиколката

SK

- S: Tlačidlo NASTAVIT':**
- Dlhé stlačenie = otvorit/zatvorit nastavenia
 - Krátke stlačenie = NASTAVIT'/OK
- M: Tlačidlo MENU:**
- Krátke stlačenie = Prepnuť/zvyšiť hodnotu
 - Dlhé stlačenie = Obnoviť údaje o dráhe

SL

- S: Gumb SET (nastavi):**
- dolg pritisk na gumb = odpri/zapri nastavitve
 - kratek pritisk na gumb = SET/OK
- M: Gumb MENU (meni):**
- kratek pritisk na gumb = preklopi/poveča vrednost
 - dolg pritisk na gumb = ponastavitev podatkov o turi

HR

- S: Gumb POSTAVI:**
- Dug pritisk = otvaranje/zatvaranje postavki
 - Kratak pritisk = POSTAVI / U REDU
- M: Gumb IZBORNIK:**
- Kratak pritisk = prebacivanje / povećavanje vrijednosti
 - Dug pritisk = ponovno postavljanje podataka o ruti

UA

- S: Кнопка «НАЛАШТУВАННЯ»:**
- довге натискання = відкрити/закрити налаштування;
 - коротке натискання = «НАЛАШТУВАННЯ»/OK.
- M: Кнопка «МЕНЮ»:**
- коротке натискання = перемикання/збільшення значення;
 - довге натискання = скидання даних про подорож.

SETTINGS MENU

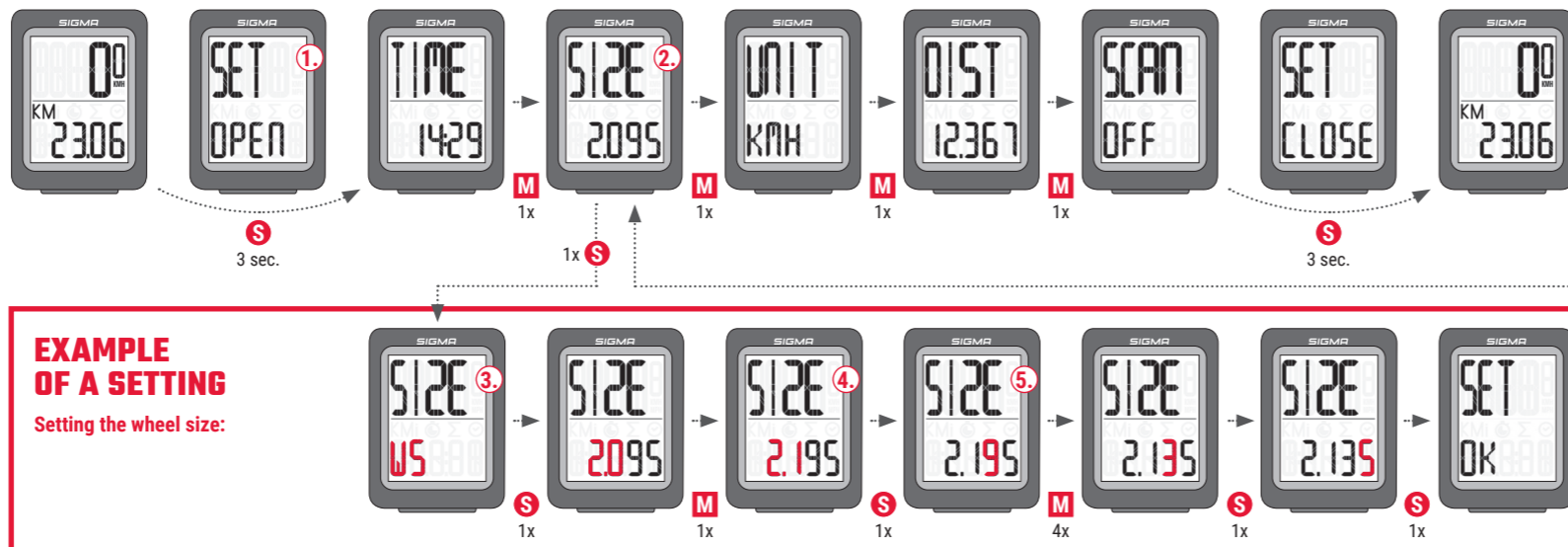

EXAMPLE OF A SETTING

Setting the wheel size:

EN EXAMPLE OF SETTING PROCEDURE:

1. **Open settings:** Press and hold **S** button >3 sec. until settings open.
2. **Choose the relevant page:** Press **M** button until desired value is displayed.
3. **Open submenu:** Press 1x **S** button.
4. **Change value:** Press **M** button until desired value is displayed.
5. **Confirm chosen value:** Press 1x **S** button.
 Note: Do steps No. 4 and No. 5 until the submenu is closed „Set Ok“.
 You are now back in the Settings Menu.
6. **Close settings:** Press and hold **S** button >3 sec.

RO EXEMPLU DE PROCEDURĂ DE SETARE:

1. **Deschideți setările:** apăsați și țineți apăsat butonul **S** >3 sec. până când se deschid setările.
2. **Alegeți pagina relevantă:** apăsați butonul **M** până când este afișată valoarea dorită.
3. **Deschideți submeniul:** apăsați 1 dată butonul **S**.
4. **Modificați valoarea:** apăsați butonul **M** până când este afișată valoarea dorită.
5. **Confirmați valoarea aleasă:** apăsați 1 dată butonul **S**.
 Notă: urmați pașii nr. 4 și nr. 5 până când submeniul este închis „Setare Ok“. Acum sunteți din nou în meniul Setări.
6. **Închideți setările:** apăsați și țineți apăsat butonul **S** >3 sec.

SL PRIMER POSTOPKA NASTAVITVE:

1. **Odpri nastavitve:** pritisnite in pridržite gumb **S** >3 sekunde oz. dokler se ne odprejo nastavitve.
2. **Izberite ustrezno stran:** pritisnite gumb **M** dokler se ne prikaže zelena vrednost.
3. **Odprite podmeni:** 1 x pritisnite gumb **S**.
4. **Spremeni vrednost:** pritisnite gumb **M** dokler se ne prikaže zelena vrednost.
5. **Potrdite izbrano vrednost:** 1 x pritisnite gumb **S**.
 Opomba: 4. in 5. korak izvajajte dokler se ne zapre podmeni „Set ok“. Po tem boste vrnjeni v meni Nastavitve.
6. **Zapri nastavitve:** pritisnite in pridržite gumb **S** >3 sekunde.

HU PÉLDA EGY BEÁLLÍTÁSI FOLYAMATRA:

1. **Nyissa meg a beállításokat:** Tartsa lenyomva a **S** (Beállítás) gombot több mint 3 másodpercig, amíg a beállítások menü meg nem nyílik.
2. **Válassza ki a megfelelő oldalt:** Nyomja meg a **M** gombot a kívánt érték megjelenéséig.
3. **Nyissa meg az almenüt:** Nyomja meg 1-szer a **S** (Beállítás) gombot.
4. **Érték megváltoztatása:** Nyomja meg a **M** gombot a kívánt érték megjelenéséig.
5. **Erősítse meg a kiválasztott értéket:** Nyomja meg 1-szer a **S** (Beállítás) gombot.
 Megjegyzés: Hajtsa végre a 4. és az 5. lépést, amíg az almenü be nem záródik: „Set Ok“ (Beállítás rendben). Ezután visszajut a beállítások menübe.
6. **Beállítások bezárása:** Tartsa lenyomva a **S** (Beállítás) gombot több mint 3 másodpercig.

BG ПРИМЕР ЗА ПРОЦЕДУРАТА ПО НАСТРОЙВАНЕ:

1. **Отваряне на настройките:** Натиснете и задръжте бутон **S** за повече от 3 секунди, докато се отворят настройките.
2. **Избиране на съответната страница:** Натиснете бутон **M**, докато се появи желаната стойност.
3. **Отваряне на подменю:** Натиснете веднъж бутон **S**.
4. **Промяна на стойност:** Натиснете бутон **M**, докато се появи желаната стойност.
5. **Потвърждаване на избраната стойност:** Натиснете веднъж бутон **S**.
 Бележка: Извършвайте стъпки 4 и 5, докато подменюто се затвори – „Настройка OK“ (Set Ok). Сега отново сте в Менюто с настройки.
6. **Затваряне на настройките:** Натиснете и задръжте бутон **S** за повече от 3 секунди.

HR PRIMJER POSTUPKA POSTAVLJANJA:

1. **Otvoravanje postavki:** pritisnite i držite gumb **S** duže od 3 sekunde, dok se ne prikaže željena vrijednost.
2. **Odabir važne stranice:** pritisnite gumb **M** dok se ne prikaže željena vrijednost.
3. **Otvoravanje podizbornika:** jednom pritisnite gumb **S**.
4. **Promjena vrijednosti:** pritisnite gumb **M** dok se ne prikaže željena vrijednost.
5. **Potvrda odabrane vrijednosti:** jednom pritisnite gumb **S**.
 Napomena: ponavljajte 4. i 5. korak dok se podizbornik ne zatvori „Postavke su u redu“. Vratili ste se u Izbornik postavki.
6. **Zatvaranje postavki:** pritisnite i držite gumb **S** duže od 3 sekunde.

CHOOSE YOUR SPECIFIC WHEEL SIZE

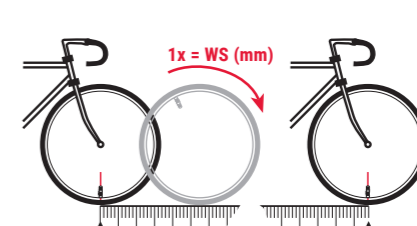

km/h:

WS = mm

mph:

WS = mm

Note: 1 inch = 25.4 mm

EXAMPLE VALUE: 2135 mm

	mm	inch
16"	1253	49,3
18"	1411	55,6
20"	1590	62,6
22"	1770	69,7
24"	1907	75,1
26"	2085	82,1
27"	2195	86,4
27.5"	2180	85,8
28"	2200	86,6
29"	2300	90,5
700C	2095	82,5

BATTERY CHANGE

BC 5.0 WR/WL



Battery: CR 2032

SPEED TRANSMITTER (BC 5.0 WL)

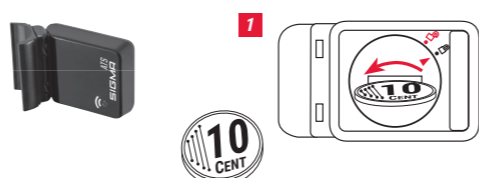

Battery: CR 2032



SIGMA-ELEKTRO GmbH
 Dr. Julius-Leber-Straße 15
 67433 Neustadt/Weinstraße, Germany
 kundenservice@sigmasport.com

